

## Table Top Rack Cabinets (RCHS Series) - *HEAVY DUTY*















**Textured - Light Gray (RAL7035)**

### ***Features:***









- Heavy duty, 16-gauge steel, 19" table top rack cabinet...
- For ventilated versions link to our [RCHV series](#)...
- Panel rails are infinitely adjustable (front to back), round hole punched for 10-32 clip-nuts to full EIA hole centers (5/8 - 5/8 - 1/2 inch spacing)...
- Includes two pairs of rails (for rear support of heavier equipment), rubber feet, black ABS plastic handles, a starter pack of 10-32 clip nuts & matching **1421ABK** black screws...
- Supplied unassembled (four cabinet pieces & four rails), shipped in a flat pack container for handling ease & protection (see photo below)...
- Simple assembly using one bolt in each corner to lock the sides to the top and bottom (hardware included)...
- Overall width 21"...
- Overall height 2" over panel space...
- Front & back lip is .585" so usable depth is reduced by 1.17"
- Recommended maximum weight (RCHS1902824 tested) - 800 pounds...
- Rugged textured powder paint finish...
- Stocked in Black & Light Gray (RAL7035)...



### **17.5" Deep models:**













Part Number	Color	 Reader File	AutoCAD .dxf File (zipped)	Panel Height		Number of Clip Nuts Included	Wt. lbs.
				Inches	Units		
<b>RCHS1900817BK1</b> <b>RCHS1900817CG1</b> <b>RCHS1900817LG1</b>	Black Beige Light Gray	 63K	 59K	<b>8.75</b>	5	8	38
<b>RCHS1901017BK1</b> <b>RCHS1901017CG1</b> <b>RCHS1901017LG1</b>	Black Beige Light Gray	 60K	 61K	<b>10.50</b>	6	16	40
<b>RCHS1901417BK1</b> <b>RCHS1901417CG1</b> <b>RCHS1901417LG1</b>	Black Beige Light Gray	 64K	 60K	<b>14.00</b>	8	16	44
<b>RCHS1901717BK1</b> <b>RCHS1901717CG1</b> <b>RCHS1901717LG1</b>	Black Beige Light Gray	 67K	 63K	<b>17.50</b>	10	16	50
<b>RCHS1902217BK1</b> <b>RCHS1902217CG1</b> <b>RCHS1902217LG1</b>	Black Beige Light Gray	 70K	 65K	<b>22.75</b>	13	16	54
<b>RCHS1902817BK1</b> <b>RCHS1902817CG1</b> <b>RCHS1902817LG1</b>	Black Beige Light Gray	 72K	 67K	<b>28.00</b>	16	16	60

**24.5" Deep models:**



Part Number	Color	 Reader File	AutoCAD .dxf File (zipped)	Panel Height		Number of Clip Nuts Included	Wt. lbs.
				Inches	Units		
<b>RCHS1901024BK1</b> <b>RCHS1901024CG1</b> <b>RCHS1901024LG1</b>	Black Beige Light Gray	 68K	 60K	<b>10.50</b>	6	16	52
<b>RCHS1901424BK1</b> <b>RCHS1901424CG1</b> <b>RCHS1901424LG1</b>	Black Beige Light Gray	 64K	 60K	<b>14.00</b>	8	16	58
<b>RCHS1901724BK1</b> <b>RCHS1901724CG1</b> <b>RCHS1901724LG1</b>	Black Beige Light Gray	 64K	 60K	<b>17.50</b>	10	16	62
<b>RCHS1902224BK1</b> <b>RCHS1902224CG1</b> <b>RCHS1902224LG1</b>	Black Beige Light Gray	 66K	 60K	<b>22.75</b>	13	16	70

<b>RCHS1902824BK1</b>	<b>Black</b>			<b>28.00</b>	16	16	78
<b>RCHS1902824CG1</b>	<b>Beige</b>						
<b>RCHS1902824LG1</b>	<b>Light Gray</b>	82K	60K				

**31.5" Deep models:**

Part Number	Color	 Reader File	AutoCAD .dxf File (zipped)	Panel Height		Number of Clip Nuts Included	Wt. lbs.
				Inches	Units		
<b>RCHS1901031BK1</b> <b>RCHS1901031LG1</b>	<b>Black</b> <b>Light Gray</b>	 62K	 54K	<b>10.50</b>	6	16	64
<b>RCHS1901431BK1</b> <b>RCHS1901431LG1</b>	<b>Black</b> <b>Light Gray</b>	 63K	 54K	<b>14.00</b>	8	16	68
<b>RCHS1901731BK1</b> <b>RCHS1901731LG1</b>	<b>Black</b> <b>Light Gray</b>	 63K	 53K	<b>17.50</b>	10	16	74
<b>RCHS1902231BK1</b> <b>RCHS1902231LG1</b>	<b>Black</b> <b>Light Gray</b>	 65K	 53K	<b>22.75</b>	13	16	86
<b>RCHS1902831BK1</b> <b>RCHS1902831LG1</b>	<b>Black</b> <b>Light Gray</b>	 66K	 54K	<b>28.00</b>	16	16	94

**Feature Views:**

<p><b>Ships Flat For Handling Ease &amp; Protection</b></p>	<p><b>Interior View With Infinitely Adjustable Panel Rails</b></p>
 <p>Wood Ends</p> <p>Corner protectors nailed to wood ends</p> <p>Banded</p>	 <p>Rails are infinitely adjustable (front to back) on anvil struts</p> <p>Base punched for easy caster mounting</p>
<p><b>Panel Rails (Two Pair Included) With 10-32 Black Clip Nuts &amp; Mounting Hardware</b></p>	



## Accessories:



### Casters - Part Number **1425PHD**













- **SOLD IN A SET OF 4**
- Base of cabinet is punched to accept this caster set
- 600# Mfg's specified weight capacity (Set of 4)
- Features ball bearing swivel and hard composition wheels
- Small foot print 2.125" x 15/16" hole mounting pattern
- Wheels are grey & 2" wheel diameter (adds only 2.5" to overall rack height).
- Includes mounting hardware



### Doors

- 16-gauge steel construction
- Both front & back of "RCHS" rack cabinets are punched to accept these doors
- Mounts either right or left hand hinge (door & cabinet are symmetrical)
- Includes installed lock and two keys
- Finished in rugged textured powder paint to match RCHS/RCHV enclosures
- Includes mounting hardware

Part Number	Color	PDF Reader	AutoCAD .dxf File	Use With Cabinet	Wt. lbs.

		File	(zipped)	Panel Height	U's
<b>RC</b> HD1908BK1 <b>RC</b> HD1908CG1 <b>RC</b> HD1908LG1	Black Beige Light Gray	 17K	 17K	8" (5 U)	5
<b>RC</b> HD1910BK1 <b>RC</b> HD1910CG1 <b>RC</b> HD1910LG1	Black Beige Light Gray	 18K	 18K	10.5" (6 U)	5
<b>RC</b> HD1914BK1 <b>RC</b> HD1914CG1 <b>RC</b> HD1914LG1	Black Beige Light Gray	 19K	 20K	14" (8 U)	6
<b>RC</b> HD1917BK1 <b>RC</b> HD1917CG1 <b>RC</b> HD1917LG1	Black Beige Light Gray	 21K	 22K	17.5" (10 U)	7
<b>RC</b> HD1922BK1 <b>RC</b> HD1922CG1 <b>RC</b> HD1922LG1	Black Beige Light Gray	 22K	 24K	22.75" (13 U)	9
<b>RC</b> HD1928BK1 <b>RC</b> HD1928CG1 <b>RC</b> HD1928LG1	Black Beige Light Gray	 24K	 27K	28" (16 U)	12



### Extra Panel Rails

- RCHS rack cabinets ship with two pair - order below for extra mounting capabilities
- **Sold in pairs**
- Finished in rugged black textured powder paint
- Includes amhal strut mounting hardware (black clip nuts are not included)

Part Number	Use With Cabinet Panel Height
<b>RCHR1908</b>	8" (5 U)
<b>RCHR1910</b>	10.5" (6 U)
<b>RCHR1914</b>	14" (8 U)
<b>RCHR1917</b>	17.5" (10 U)
<b>RCHR1922</b>	22.75" (13 U)



### Extra Spring Nuts - Part Number **1421SN**

- 1/4 - 20 Strut nut
- 1/4 - 20 x 1/2 bolt
- Used only in our RCHS & RCHV table top rack cabinets - handy for mounting of other equipment to the horizontal struts
- **Sold in packages of 8 (8 spring nuts and 8 bolts) as shown**



### Replacement Rubber Feet - Part Number **1421RC24**

- RCHS rack cabinets ship with four feet included - order these for replacement
- **Sold in package of 20**



PART No. RCHS1902817

for more information visit  
[www.hammfg.com](http://www.hammfg.com)

Data subject to change without notice.  
Isometric drawing not to scale.  
Shipped knockdown for handling ease  
& protection.

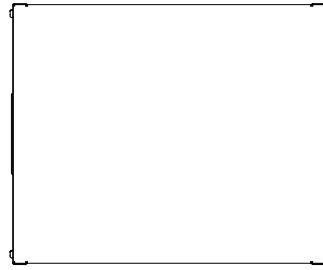

TOP VIEW

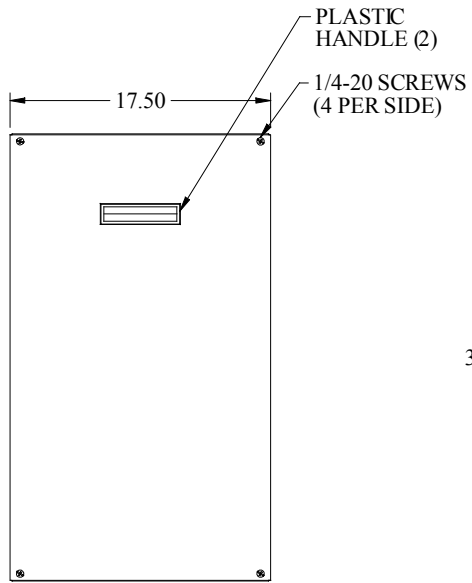
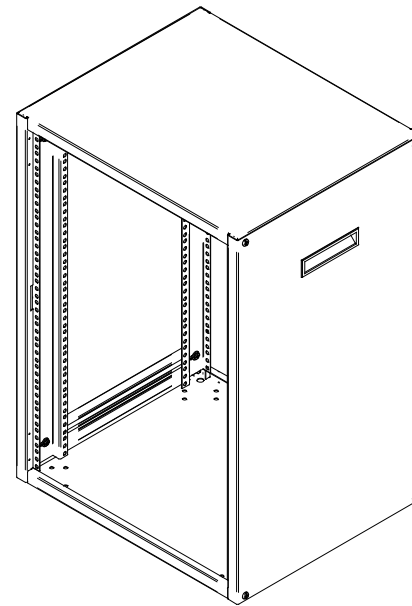

L.S. VIEW

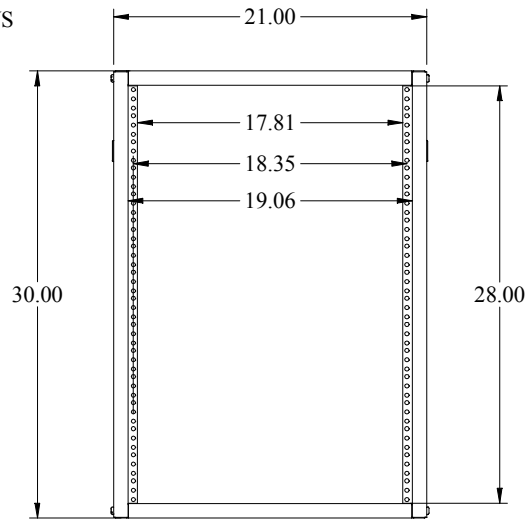

FRONT VIEW

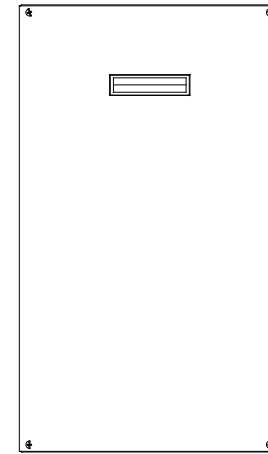

R.S. VIEW

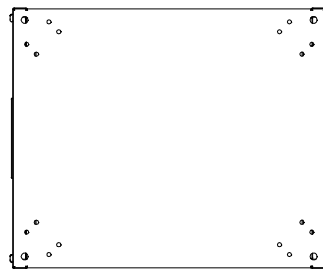

BOTTOM VIEW